

"ORANGE LINE" AC Contactors, AC Operated



■ NON-REVERSING CONTACTORS UL File No. E42419, E44592 cUL listed

1 Phase HP Rating (Full load ampere)		3 Phase HP Ratings (Full load ampere)				Rated thermal current for non inductive / resistive load	Qty. of Auxiliary Contacts	Part Number	Fuji Type	Frame Size
100-120V	220-240V	200-208V	220-240V	440-480V	550-600V					
1/3 (7.2)	1 (8)	2 (7.8)	2 (6.8)	5 (7.6)	5 (6.1)	11	1	4NC0A0#@@%	SC-03	0A
1/3 (7.2)	1 (8)	3 (11)	3 (9.6)	5 (7.6)	5 (6.1)	13	1	4NC0F0#@@%	SC-0	0F
1/3 (7.2)	1 (8)	3 (11)	3 (9.6)	5 (7.6)	5 (6.1)	13	2	4NC0G0#@@%	SC-05	0G
1 (16)	2 (12)	5 (17.5)	5 (15.2)	7 1/2 (11)	7 1/2 (9)	20	1	4NC0Q0#@@%	SC-4-0	0Q
1 (16)	2 (12)	5 (17.5)	5 (15.2)	10 (14)	10 (11)	20	1	4NC0R0#@@%	SC-4-1	0R
1 (16)	2 (12)	5 (17.5)	5 (15.2)	10 (14)	10 (11)	20	2	4NC0H0#@@%	SC-5-1	0H

■ REVERSING CONTACTORS UL File No. E42419, E44592 cUL listed

1 Phase HP Rating (Full load ampere)		3 Phase HP Ratings (Full load ampere)				Rated thermal current for non inductive / resistive load	Qty. of Auxiliary Contacts	Part Number	Fuji Type	Frame Size
100-120V	220-240V	200-208V	220-240V	440-480V	550-600V					
1/3 (7.2)	1 (8)	2 (7.8)	2 (6.8)	5 (7.6)	5 (6.1)	11	1	4ND0A0#@@%	SC-03RM	0A
1/3 (7.2)	1 (8)	3 (11)	3 (9.6)	5 (7.6)	5 (6.1)	13	1	4ND0F0#@@%	SC-0RM	0F
1/3 (7.2)	1 (8)	3 (11)	3 (9.6)	5 (7.6)	5 (6.1)	13	2	4ND0G0#@@%	SC-05RM	0G
1 (16)	2 (12)	5 (17.5)	5 (15.2)	7 1/2 (11)	7 1/2 (9)	20	1	4ND0Q0#@@%	SC-4-0RM	0Q
1 (16)	2 (12)	5 (17.5)	5 (15.2)	10 (14)	10 (11)	20	1	4ND0R0#@@%	SC-4-1RM	0R
1 (16)	2 (12)	5 (17.5)	5 (15.2)	10 (14)	10 (11)	20	2	4ND0H0#@@%	SC-5-1RM	0H

Note: The list above indicates the No. of auxiliary contacts provided per contactor.

If larger contactors are required, please turn to page 21.

EXPLANATION OF PART NUMBER SYSTEM

4 N C 0 A 0 # @ @ %

• **PRODUCT LINE**
4=Orange Line

• **OPERATION**
N=AC Coil
G=DC Coil

• **DESCRIPTION**
C=Non-Reversing Contactor
D=Reversing Contactor

• **FRAME SIZE**

• **TERMINAL OPTION**

Blank: Standard
Y: Optional, non removable terminal cover accessory.
(Note: Y type not available for 0Q or 0R frame sizes)

• **QUANTITY OF AUX. CONTACTS**

10 : 1NO 20 : 2NO
01 : 1NC 02 : 2NC

11 : 1NO+1NC

See above under the "Qty. of Aux Contacts" column or next page.

• **COIL VOLTAGE**

Select code from chart on next page

• **FRAME ENCLOSURE**

0=Open Frame, No Enclosure

"ORANGE LINE" AC Contactors, AC Operated

AVAILABLE COILS

Code Letter	AC Coil 60Hz	AC Coil 50Hz
E	24-26V	24V
F	48-52V	48V
A	100-110V	100V
1	110-120V	100-110V
G	120-130V	110-120V
B	200-220V	200V
2	220-240V	200-220V
C	400-440V	380-400V
4	440-480V	415-440V
5	550-600V	500-550V

If DC operation is required, please turn to page 7-8.

COIL CHARACTERISTICS

Frame Size	Power Consumption (VA)		Pick-up Voltage (V)	Drop-out Voltage (V)	Operating Time (ms)	
					Coil ON	Coil OFF
Inrush Sealed					Contact ON	Contact OFF
0A	95	9	58-68	40-55	9-20	5-16
0F	95	9	58-68	40-55	9-20	5-16
0G	95	9	58-68	40-55	9-20	5-16
0Q	95	9	65-73	44-60	9-20	5-16
0R	95	9	65-73	44-60	9-20	5-16
0H	95	9	65-73	44-60	9-20	5-16

This data is based on 110-120VAC, 50/60Hz coil, tested at 120VAC, 60Hz. For additional coil data, please see page 49.

WIRING DIAGRAMS / AUXILIARY CONTACT INFORMATION

NON-REVERSING CONTACTORS

(4NC0A0, 0F0, 0Q0 and 0R0)

1NO* (Standard)*

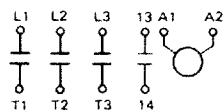

(4NC0G0 and 4NC0H0)

1NO+1NC (Standard)**

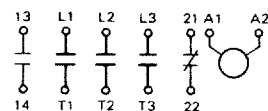

1NC* (Option)

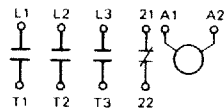

2NO** (Option)

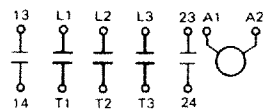

2NC** (Option)

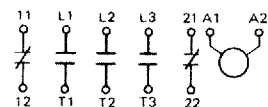

REVERSING CONTACTORS

(4ND0A0, 0F0, 0Q0, 0R0)

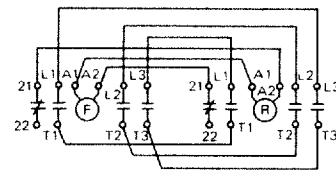

(4ND0G0 and 4ND0H0)

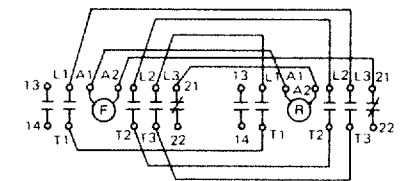

AUXILIARY CONTACT RATINGS

Operating	Contact rating Code Designation	Continuous Ampere Rating	Current-Make/Break (A)			
			110 to 120V	220 to 240V	440 to 480V	550 to 600V
AC	A600	10	60/6	30/3	15/1.5	12/1.2
DC	Q300	10	120V		240V	
			0.55/0.55		0.27/0.27	

* The 0A, 0F, 0Q & 0R frames offer 1 Aux. contact, NO standard. However, NC is available as an option.

** The 0G & 0H frames offer 2 Aux. contacts, 1NO + 1NC standard. However, 2NO or 2NC is available as an option.

"ORANGE LINE" Dimensions

■ NON-REVERSING CONTACTORS/OPEN TYPE Approximate Dimensions, mm

FIG.1 (4NC0A0 through 4NC0H0)

4NC0A0, 0F0, 0Q0, 0R0

4NC0G0, 0H0

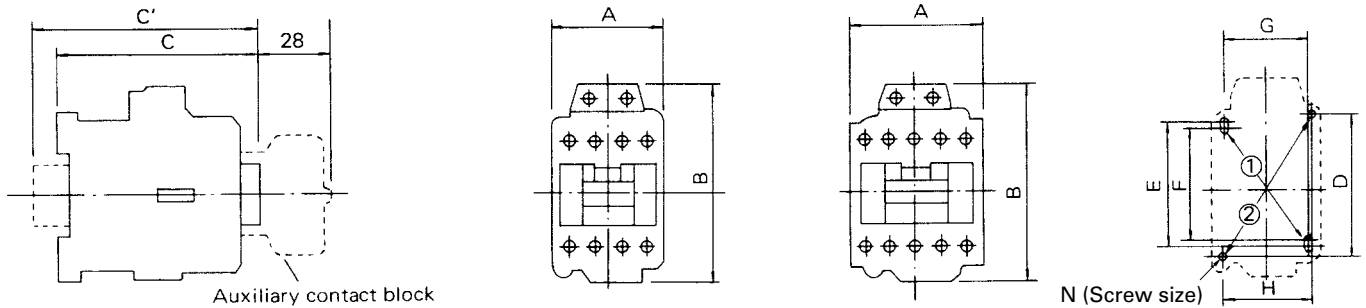

U.S. CAT. No.	Fuji Type	Fig. No.	Dimensions, mm										Net Weight (kg)
			A	B	C	C'	D	E	F	G	H	N	
4NC0A0	SC-03	1	43	80	80	90	60	52	48	34	35	2-M4	0.32
4NC0F0	SC-0	1	43	80	80	90	60	52	48	34	35	2-M4	0.32
4NC0G0	SC-05	1	53	80	80	90	60	52	48	34	35	2-M4	0.34
4NC0Q0	SC-4-0	1	53	80	81	91	60	52	48	34	35	2-M4	0.36
4NC0R0	SC-4-1	1	53	80	81	91	60	52	48	34	35	2-M4	0.36
4NC0H0	SC-5-1	1	64	80	81	91	60	60	56	54	50	2-M4	0.38
4GC0A0	SC-03/G	1	43	80	110	120	60	52	48	34	35	2-M4	0.55
4GC0F0	SC-0/G	1	43	80	110	120	60	52	48	34	35	2-M4	0.55
4GC0G0	SC-05/G	1	53	80	110	120	60	52	48	34	35	2-M4	0.58
4GC0Q0	SC-4-0/G	1	53	80	111	121	60	52	48	34	35	2-M4	0.6
4GC0R0	SC-4-1/G	1	53	80	111	121	60	52	48	34	35	2-M4	0.6
4GC0H0	SC-5-1/G	1	64	80	111	121	60	60	56	54	50	2-M4	0.62

FIG.2 (4NW0A0 through 4NW0H0)

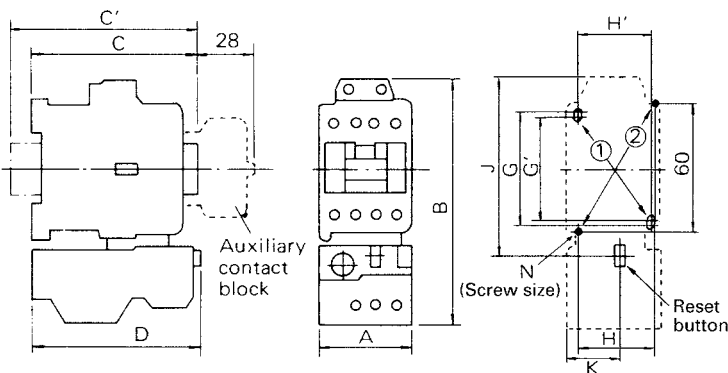

U.S. CAT. No.	Fuji Type	Fig. No.	Dimensions, mm													Net Weight (kg)
			A	B	C	C'	D	F	G	G'	H	H'	J	K	N	
4NW0A0	SW-03/2E	2	44	120	80	90	81	60	52	48	35	34	90	26.5	2-M4	0.43
4NW0F0	SW-0/2E	2	44	120	80	90	81	60	52	48	35	34	90	26.5	2-M4	0.43
4NW0G0	SW-05/2E	2	53	120	80	90	81	60	52	48	35	34	90	35.5	2-M4	0.45
4NW0Q0	SW-4-0/2E	2	53	126	81	91	81	60	52	48	35	34	93	26.5	2-M4	0.47
4NW0R0	SW-4-1/2E	2	53	126	81	91	81	60	52	48	35	34	93	26.5	2-M4	0.47
4NW0H0	SW-5-1/2E	2	64	126	81	91	81	60	60	56	50	54	93	37.5	2-M4	0.5
4GW0A0	SW-03/G 2E	2	44	120	110	120	81	60	52	48	35	34	90	26.5	2-M4	0.66
4GW0F0	SW-0/G 2E	2	44	120	110	120	81	60	52	48	35	34	90	26.5	2-M4	0.66
4GW0G0	SW-05/G 2E	2	53	120	110	120	81	60	52	48	35	34	90	35.5	2-M4	0.69
4GW0Q0	SW-4-0/G 2E	2	53	126	111	121	81	60	52	48	35	34	93	26.5	2-M4	0.72
4GW0R0	SW-4-1/G 2E	2	53	126	111	121	81	60	52	48	35	34	93	26.5	2-M4	0.72
4GW0H0	SW-5-1/G 2E	2	64	126	111	121	81	60	60	56	50	54	93	37.5	2-M4	0.74

TECHNICAL PERFORMANCE DATA

■ STANDARD CONDITIONS

- Ambient temperature should not exceed +40°C and the average over a period of 4 hours should not exceed +35°C. The lower limit of the ambient temperature is -5°C.
- Altitude Restriction
For use at altitudes exceeding 2000 meters (6,600 ft.) please consult Fuji Electric.

■ LIFE EXPECTANCY

Performance Data

Frame size	Current capacity Make/Break	Operating cycles per hour	Life expectancy (million operations)	
			Electrical	Mechanical
0A	12xIe/10xIe	1800	2	10
0F, 0G	12xIe/10xIe	1800	2	10
0Q	12xIe/10xIe	1800	1.5	10
0R, 0H	12xIe/10xIe	1800	2	10
0T, 1Q	12xIe/10xIe	1200	2	10
2F, 2H	12xIe/10xIe	1200	2	5
2T through 5F	12xIe/10xIe	1200	1	5
5H	12xIe/10xIe	1200	0.5	5

■ AUXILIARY CONTACT RATINGS

All Frame Sizes

Operating	Contact rating code designation	Continuous ampere rating	Current-Make/Break (A)			
			110 to 120V	220 to 240V	440 to 480V	550 to 600V
AC	A600	10	60/6	30/3	15/1.5	12/1.2
DC	Q300	10	120V		240V	
			0.55/0.55		0.27/0.27	

Note: Ie: Rated operational current.

Electrical life test: Conforming to IEC947-4-1, AC3.

The endurance test complies with the requirements of international standard IEC, JIS and JEM.

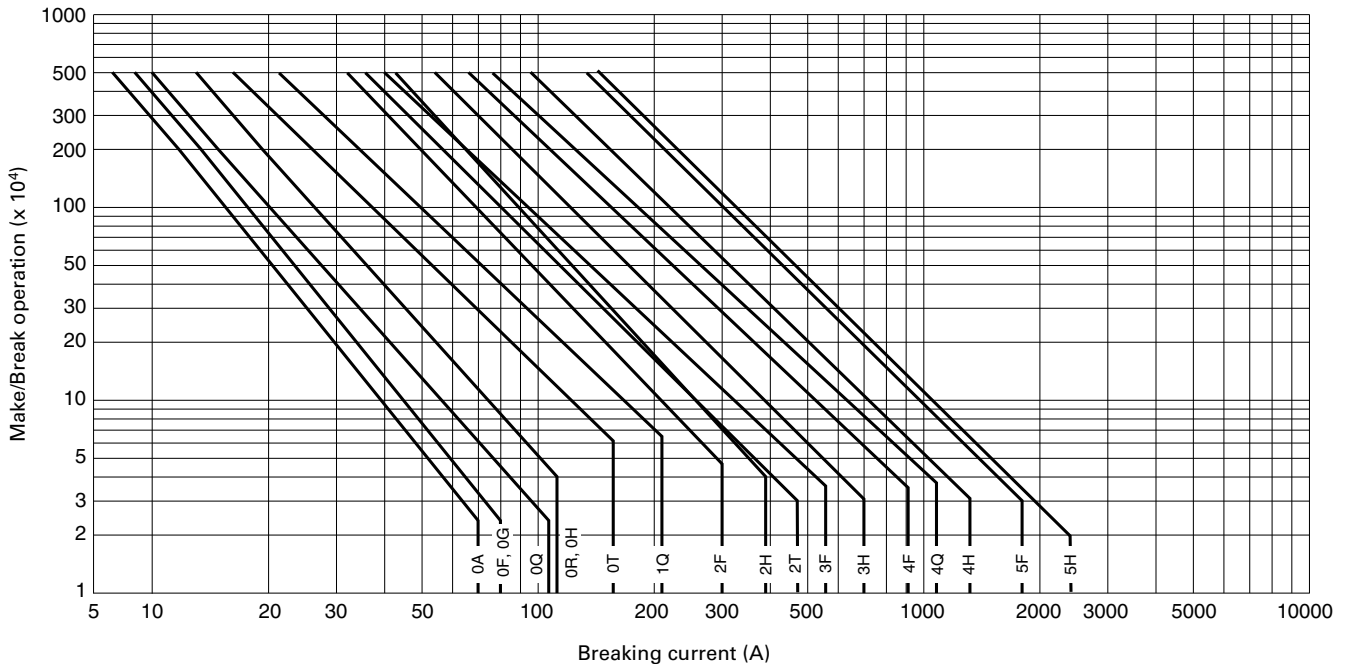

Terminal Tightening Torque Chart

Type No.		Terminal Size		Cable Size Maximum		Applicable Max. Width for Ring Terminal		Tightening Torque	
Contact or Starter	Thermal Overload Relay	Contact	Thermal Overload Relay	Contact	Thermal Overload Relay	Contact	Thermal Overload Relay	Contact	Thermal Overload Relay
4NC0A0 4NC0F0 4NC0G0 4NW0A0 4NW0F0 4NW0G0	4NK0A	M3.5	M3.5	12AWG (3.3mm ²)	12AWG (3.3mm ²)	7.7mm	7.7mm	7-9 in.lbs. 0.8-1 Nm	7-9 in.lbs. 0.8-1 Nm
4NC0Q0 4NC0R0 4NC0H0 4NW0Q0 4NW0R0 4NW0H0	4NK0H	M4	M4	10AWG (5.3mm ²)	10AWG (5.3mm ²)	9.7mm	9.7mm	11-13 in.lbs. 1.2-1.5 Nm	11-13 in.lbs. 1.2-1.5 Nm
3NC0T0 3NC1Q0 3NW0T0 3NW1Q0	3NK1Q	M5	M5	6AWG (13.3mm ²)	6AWG (13.3mm ²)	12.4mm	12.4mm	18-22 in.lbs. 2-2.5 Nm	18-22 in.lbs. 2-2.5 Nm
3NC2F0 3NC2H0 3NW2F0 3NW2H0	3NK2H	M6	M6	2AWG (33.6mm ²)	4AWG (21.2mm ²)	16.8mm	16.7mm	35-44 in.lbs. 4-5 Nm	35-44 in.lbs. 4-5 Nm
3NC2T0 3NC3F0 3NW2T0 3NW3F0	3NK3F	M6	M6	1/0AWG (53.5mm ²)	2AWG (33.6mm ²)	22.3mm	16.7mm	35-44 in.lbs. 4-5 Nm	35-44 in.lbs. 4-5 Nm
3NC3H0 3NW3H0	3NK3H	M8	M8	1/0AWG (53.5mm ²)	1/0AWG (53.5mm ²)	22.3mm	22.3mm	80-97 in.lbs. 9-11 Nm	80-97 in.lbs. 9-11 Nm
3NC4F0 3NW4F0	3NK4F	M8	M8	3/0AWG (85mm ²)	1/0AWG (53.5mm ²)	28.9mm	22.3mm	80-97 in.lbs. 9-11 Nm	80-97 in.lbs. 9-11 Nm
3NC4Q0 3NW4Q0	3NK4Q	M10	M10	300MCM (152mm ²)	300MCM (152mm ²)	36.5mm	36.5mm	133-177 in.lbs. 15-20 Nm	133-177 in.lbs. 15-20 Nm
3NC4H0 3NW4H0	3NK4H	M10	M10	300MCM (152mm ²)	300MCM (152mm ²)	36.5mm	36.5mm	133-177 in.lbs. 15-20 Nm	133-177 in.lbs. 15-20 Nm
3NC5F0 3NC5H0 3NW5F0 3NW5H0	3NK5H	M12	M12	400MCM (203mm ²)	400MCM (203mm ²)	44.5mm	44.5mm	310-399 in.lbs. 35-45 Nm	310-399 in.lbs. 35-45 Nm
3NC6F0 3NC6H0	-	M16	-	600MCM (304mm ²)	-	51.0mm	-	663-884 in.lbs. 75-100 Nm	-